

vtech®

Safe & Sound™ Video and audio monitor

User's manual

www.babymonitors.vtech.com



Models:
VM321/VM321-2



24
GHz

Congratulations

on purchasing your new VTech product. Before using this product, please read **Important safety instructions** on pages iii-iv of this manual.

This manual has all the feature operations and troubleshooting necessary to install and operate your new VTech product. Please review this manual thoroughly to ensure proper installation and operation of this innovative and feature rich VTech product. For support, shopping, and everything new at VTech, visit our website at www.babymonitors.vtech.com. In Canada, please visit www.vtechcanada.com.

Register online to get an additional 3-month warranty!

Visit www.vtechphones.com.



Registration

Register your product online for enhanced warranty support.



Product news

Learn about the latest VTech products.

Product introduction

VM321 is a video and audio monitor which consists of one parent unit (**VM321 PU**) and one baby unit (**VM321 BU**).

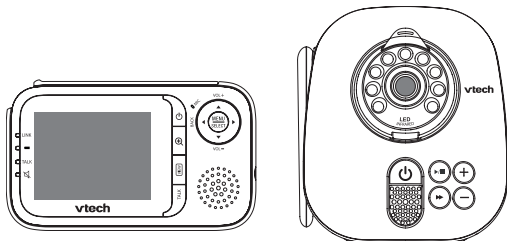

VM321-2 is a video and audio monitor which consists of one parent unit (**VM321-2 PU**) and two baby units (**VM321-2 BU**).

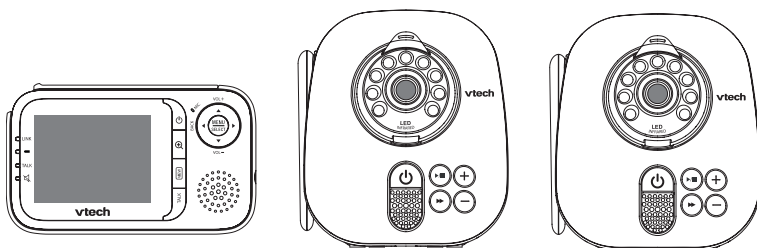

The parent unit may be shipped with a protective sticker covering the display. Remove the protective sticker before use.

Important safety instructions

When using your equipment, basic safety precautions should always be followed to reduce the risk of fire, electric shock and injury, including the following:

1. Follow all warnings and instructions marked on the product.
2. Adult setup is required.
3. This product is intended as an aid. It is not a substitute for responsible and proper adult supervision and should not be used as such.
4. This product is not intended for use as a medical monitor.
5. Do not use this product near water. For example, do not use it next to a bath tub, wash bowl, kitchen sink, laundry tub or swimming pool, or in a wet basement or shower.
6. **CAUTION:** Use only the batteries indicated in this manual. There may be a risk of explosion if a wrong type of battery is used for the parent unit. Use only the supplied rechargeable battery or replacement battery pack (BT298555) for the parent unit. Do not dispose of batteries in a fire. They may explode. Dispose of used battery according to the information in **The RBRC® seal** (see page 39).
7. Use only the adapters included with this product. Incorrect adapter polarity or voltage can seriously damage the product.
Baby unit power adapter: Input 100-120V AC 50/60 Hz; output: 6V DC 800 mA
Parent unit power adapter: Input 100-120V AC 50/60 Hz; output: 6V DC 800 mA
8. The power adapters are intended to be correctly oriented in a vertical or floor mount position. The prongs are not designed to hold the plug in place if it is plugged into a ceiling, under-the-table or cabinet outlet.
9. Unplug this product from the wall outlet before cleaning. Do not use liquid or aerosol cleaners. Use a damp cloth for cleaning.
10. Unplug the power cords before replacing batteries.
11. Do not cut off the power adapters to replace them with other plugs, as this causes a hazardous situation.
12. Do not allow anything to rest on the power cords. Do not install this product where the cords may be walked on or crimped.
13. This product should be operated only from the type of power source indicated on the marking label. If you are not sure of the type of power supply in your home, consult your dealer or local power company.
14. Do not overload wall outlets or use an extension cord.
15. Do not place this product on an unstable table, shelf, stand or other unstable surfaces.
16. This product should not be placed in any area where proper ventilation is not provided. Slots and openings in the back or bottom of this product are provided for ventilation. To protect them from overheating, these openings must not be blocked by placing the product on a soft surface such as a bed, sofa or rug. This product should never be placed near or over a radiator or heat register.
17. Never push objects of any kind into this product through the slots because they may touch dangerous voltage points or create a short circuit. Never spill liquid of any kind on the product.

Important safety instructions (continued)

18. To reduce the risk of electric shock, do not disassemble this product, but take it to an authorized service facility. Opening or removing parts of the product other than specified access doors may expose you to dangerous voltages or other risks. Incorrect reassembling can cause electric shock when the product is subsequently used.
19. You should test the sound reception every time you turn on the units or move one of the components.
20. Periodically examine all components for damage.
21. Be aware of possible loss of privacy while using public airwaves. Conversations may be picked up by other nursery monitors, cordless phones, scanners, etc.
22. Children should be supervised to ensure that they do not play with the product.
23. The product is not intended for use by persons (including children) with reduced physical, sensory or mental capabilities, or lack of experience and knowledge, unless they have been given supervision or instruction concerning use of the appliance by a person responsible for their safety.

SAVE THESE INSTRUCTIONS

Cautions

1. Use and store the product at a temperature between 32°F and 104°F.
2. Do not expose the product to extreme cold, heat or direct sunlight. Do not put the product close to a heating source.
3. Batteries should not be exposed to excessive heat such as bright sunshine or fire.
4. Make sure the baby unit(s) and the adapter cord(s) are always out of reach of the baby, at least 3 feet away from the baby or crib, to avoid a possible strangulation hazard.
5. Never place the baby unit(s) inside the baby's crib or playpen.
6. Never cover the baby unit(s) or parent unit with anything such as a towel or a blanket.
7. Other electronic products may cause interference with your video and audio monitor. Try installing your video and audio monitor as far away from these electronic devices as possible: wireless routers, radios, cellular telephones, intercoms, room monitors, televisions, personal computers, kitchen appliances and cordless telephones.

Electromagnetic fields (EMF)

This VTech product complies with all standards regarding electromagnetic fields (EMF). If handled properly and according to the instructions in this user's manual, the product is safe to be used based on scientific evidence available today.

Table of contents

Getting started	1	Baby unit operation	29
Parts checklist	1	Power on or off the baby unit.....	29
Baby unit battery installation	2	Speaker volume.....	29
Baby unit installation	3	Play lullabies.....	29
Baby unit installation options.....	4	Night vision	29
Tabletop to wall			
mount installation	4	Parent unit operation	30
Parent unit battery installation	10	Power on or off the parent unit.....	30
Parent unit installation	12	Speaker volume	30
Parent unit battery charging	13	Zoom	30
Baby unit overview	14	View.....	31
Baby unit lights	15	Talk to the baby unit.....	31
Parent unit overview.....	16		
Parent unit lights.....	17	Appendix	32
Parent unit display screen icons	18	Parent unit display	
Positioning and operating range.....	19	screen messages	32
Position the video and audio		Parent unit battery	33
monitor.....	19	Troubleshooting.....	34
Audio settings	19	Operating range.....	38
Operating range.....	19	Energy-saving charging mode	38
Test your video and audio monitor		Precautions for users of implanted	
before use	20	cardiac pacemakers	38
		Maintenance	39
Parent unit settings	21	The RBRC® seal	39
Using the menu	21	Limited warranty	40
Alert tone	21	FCC and IC regulations	42
Low battery tone alert.....	21	FCC Part 15.....	42
No link alert.....	22	Industry Canada	42
Sensitivity	23	RF radiation exposure	
Temperature	24	statement	42
Minimum temperature	24	Technical specifications	43
Maximum temperature	24		
Temperature alert	25		
Temperature format	25		
Vibration	26	Index	44
Sound-activated screen.....	26		
LCD brightness.....	27		
Pair/unpair CAM	27		
Pair new CAM.....	27		
Unpair CAM	28		
Language.....	28		

Getting started

Parts checklist

Check to make sure the package contains the following items. Save your sales receipt and original packaging in the event warranty service is necessary.

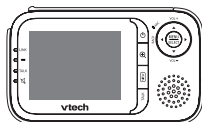

Parent unit
(VM321 PU/VM321-2 PU)

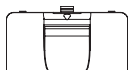

Parent unit battery
compartment cover *



Battery for
parent unit *



Baby unit
(VM321 BU/VM321-2 BU)
(1 for VM321)
(2 for VM321-2)



Baby unit battery
compartment cover *
(1 for VM321)
(2 for VM321-2)

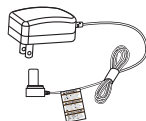

Baby unit
power adapter *
(1 for VM321)
(2 for VM321-2)

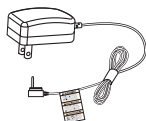

Parent unit
power adapter *



Screws *
(2 for VM321)
(4 for VM321-2)



Wall anchors *
(2 for VM321)
(4 for VM321-2)



Wall mount *
(1 for VM321)
(2 for VM321-2)

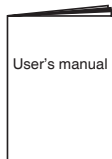

User's manual *

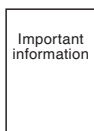

Important
information *

* indicates replacements are available. For more information, visit our website at www.babymonitors.vtech.com or call 1 (800) 595-9511. In Canada, go to www.vtechcanada.com or call 1 (800) 267-7377.

Getting started

Baby unit battery installation

You can power up the baby unit by connecting it to AC power or to four AA alkaline batteries. Even if the baby unit is connected to AC power, we recommend you also install four AA alkaline batteries. This guarantees continual operation in case of a power outage.

Install four AA alkaline batteries (not supplied) into the battery compartment, matching the polarity markings (+ and -) inside the battery compartment.

Make sure the ribbon attached inside the battery compartment is put under the batteries and the excess ribbon is tucked in properly. Then replace the battery compartment cover.

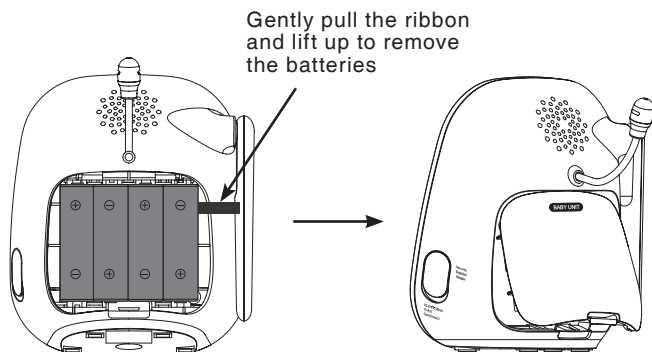

note

- Do not mix old and new batteries. Do not mix alkaline and standard (carbon-zinc) batteries.
- The operating time for using AA batteries is short, only for a few hours. If you want to monitor your baby for a long time, we recommend you connect your baby unit to AC power.
- If the baby unit will not be used for a long time, disconnect and remove the battery to prevent possible leakage.
- You can use rechargeable AA batteries for the baby unit, but the baby unit cannot charge rechargeable batteries.

Getting started

Baby unit installation

Install the baby unit as shown below.

Make sure that the power outlet is not controlled by a wall switch. Bundle the power cord neatly with the self-adhesive strap.

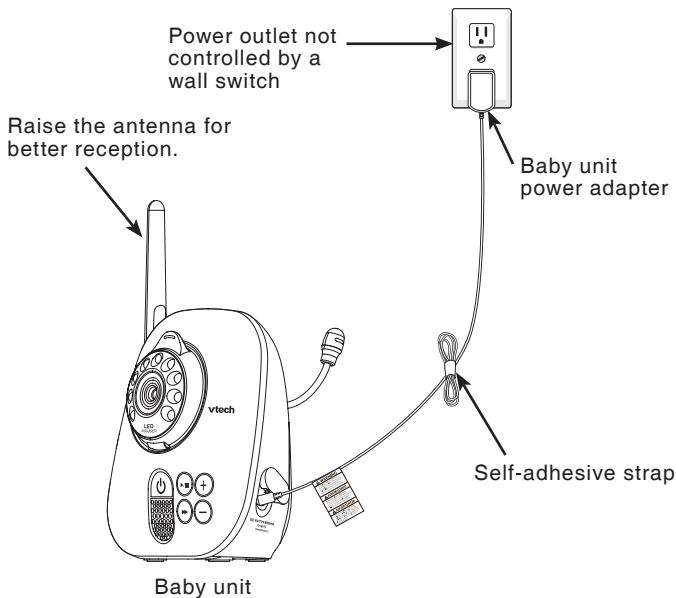

note

- Use only the baby unit power adapters supplied with this product. To order a replacement, visit our website at www.babymonitors.vtech.com or call 1 (800) 595-9511. In Canada, go to www.vtechcanada.com or call 1 (800) 267-7377.
- The baby unit power adapters are intended to be correctly oriented in a vertical or floor mount position. The prongs are not designed to hold the plug in place if it is plugged into a ceiling, under-the-table or cabinet outlet.
- Make sure the baby units and the power adapter cords are out of reach of children.

Getting started

Baby unit installation options

The baby unit is ready for tabletop use. Use the provided wall mount if you want to mount it on a wall. Make sure to test the reception and the baby unit position before completing the wall mounting installation (see **Test your video and audio monitor before use** on page 20).

Tabletop to wall mount installation

Option 1: Use this method to fix the wall mount securely on the wall.

1. Place the wall mount on a wall and then use a pencil to mark the top two holes as shown. Then remove the wall mount and drill two holes in the wall (7/32" drill bit). Check for reception strength and camera angle before drilling the holes.

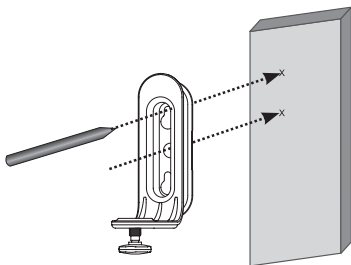

2. If you drill the holes into a stud, go to step 3.

-OR-

If you drill the holes into an object other than a stud, insert the wall anchors into the holes and tap gently on the ends with a hammer until the wall anchors are flush with the wall.



Getting started

Baby unit installation options (continued)

3. Align the wall mount and screws with the holes in the wall as shown. Make sure to attach the screw in the middle hole first so that the wall mount position is fixed. Then attach the other screw in the top hole.

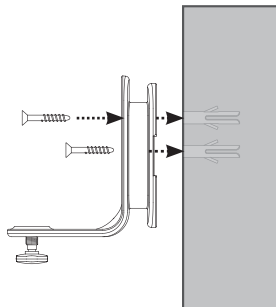

4. Place the baby unit on the wall mount and tighten the screw into the threaded socket at the bottom to secure the baby unit.

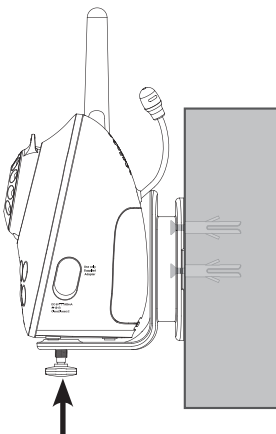

Getting started

Baby unit installation options (continued)

5. Bundle the power cord neatly with the self-adhesive strap. Make sure to keep the power adapter cord away from children's reach.

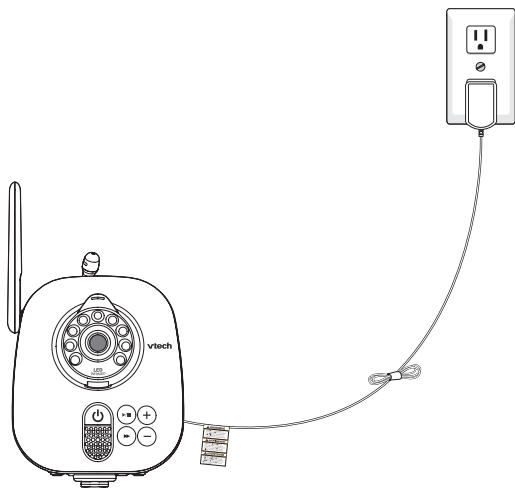

Getting started

Baby unit installation options (continued)

Option 2: Use this method so that you can relocate the baby unit with the wall mount easily.

1. Place the wall mount on a wall and then use a pencil to mark the top and the bottom holes as shown. Then remove the wall mount and drill two holes in the wall (7/32" drill bit). Check for reception strength and camera angle before drilling the holes.

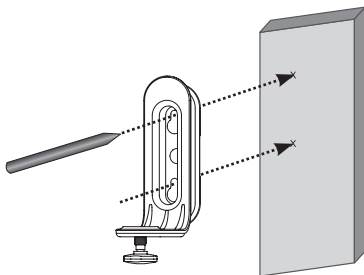

2. If you drill the holes into a stud, go to step 3.

-OR-

If you drill the holes into an object other than a stud, insert the wall anchors into the holes and tap gently on the ends with a hammer until the wall anchors are flush with the wall.



Getting started

Baby unit installation options (continued)

3. Insert the screws into the holes and tighten the screws until only 1/4 inch of the screws are exposed.

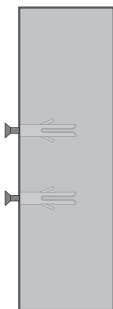

4. Place the baby unit on the wall mount and tighten the screw into the threaded socket at the bottom to secure the baby unit. Align the holes on the wall mount with the screws on the wall and slide the wall mount down until it locks into place.

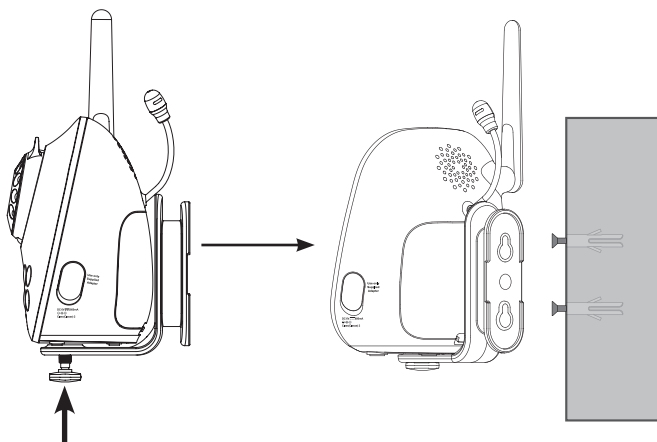

Getting started

Baby unit installation options (continued)

5. Bundle the power cord neatly with the self-adhesive strap. Make sure to keep the power adapter cord away from children's reach.

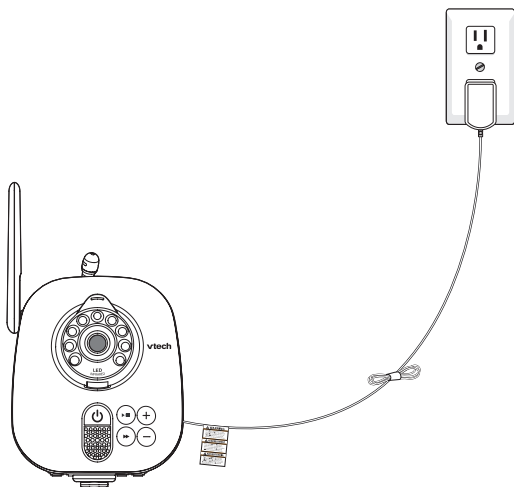

Getting started

Parent unit battery installation

You can power up the parent unit by connecting it to AC power or to the rechargeable battery provided. Even if the parent unit is connected to AC power, we recommend you also install the battery. This guarantees continual operation in case of a power outage.

Install the battery as shown below.

1. With the label **THIS SIDE UP** facing up, insert the small tabs of the battery into the slots inside the battery compartment. Make sure the metallic contact is correctly oriented as shown below. Push the battery into the battery compartment until it clicks securely into place.

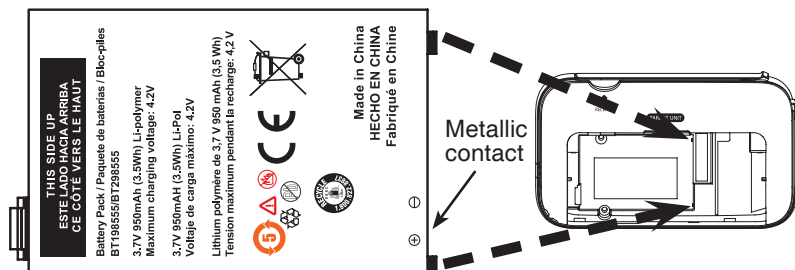

2. Align the battery compartment cover flat against the battery compartment, then slide it towards the center of the parent unit until it clicks into place.

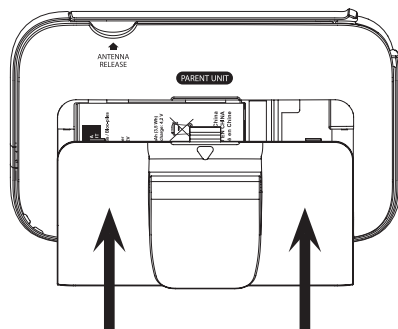

Getting started

Parent unit battery installation (continued)

To replace the battery, press down on the large tab of the battery and pull it out of the battery compartment, then follow the steps on page 10 to install the battery.

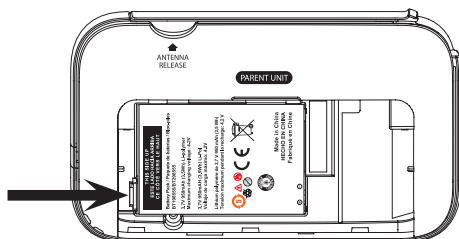

note

- The operating time for using the rechargeable battery is short. If you want to monitor your baby for a long time, we recommend you connect the parent unit to AC power.
- If the parent unit will not be used for a long time, disconnect and remove the battery to prevent possible leakage.
- Use only the battery supplied with this product. To purchase a replacement battery, visit our website at www.babymonitors.vtech.com or call 1 (800) 595-9511. In Canada, go to www.vtechcanada.com or call 1 (800) 267-7377.

Getting started

Parent unit installation

Install the parent unit as shown below.

Make sure that the power outlet is not controlled by a wall switch. Bundle the adapter cord neatly with the attached self-adhesive strap.

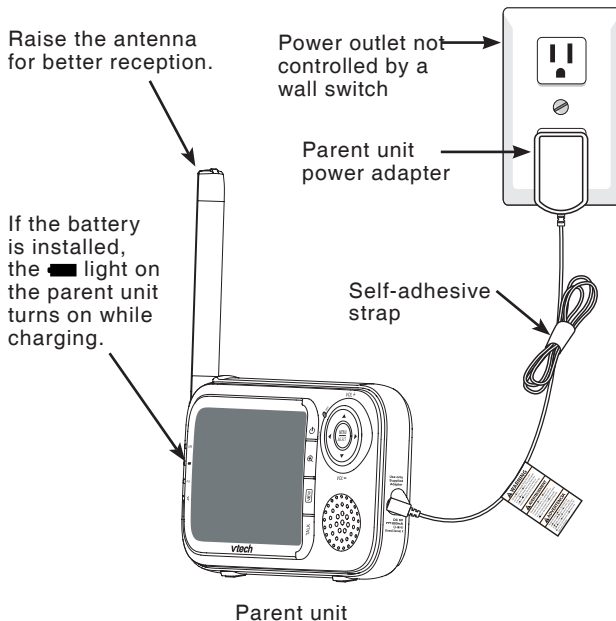



note

- Use only the parent unit power adapter supplied with this product. To order a replacement, visit our website at www.babymonitors.vtech.com or call 1 (800) 595-9511. In Canada, go to www.vtechcanada.com or call 1 (800) 267-7377.
- The parent unit power adapter is intended to be correctly oriented in a vertical or floor mount position. The prongs are not designed to hold the plug in place if it is plugged into a ceiling, under-the-table or cabinet outlet.
- Make sure the parent unit and the power adapter cord are out of reach of children.





Getting started

Parent unit battery charging

Once you have installed the parent unit (see page 12) and its battery (see page 10), press  for 2 seconds to turn it on. The battery icon indicates the battery status (see the table below). The parent unit battery is fully charged after 12 hours of continuous charging.

When the parent unit is operating in battery mode and the battery is low, you need to charge the parent unit without interruption for at least 30 minutes to give the parent unit enough charge to use for a short time. When operating in low battery condition, the parent unit displays **Battery low at Parent Unit** and . The  light on the parent unit flashes and the parent unit plays short beeps to alert you.

The following table summarizes the battery charge indicators and actions to take.

Battery indicators	Battery status	Action
The battery icon is off and  displays.	No battery is installed but operates using AC power, or the battery has been installed incorrectly.	Install the parent unit battery. Charge without interruption (at least 30 minutes).
The screen displays Battery low at Parent Unit and  . The  light flashes.	The battery has very little charge and may be used for only a short time.	Charge without interruption (about 30 minutes).
The battery icon becomes solid  .	The battery is fully charged.	To keep the battery charged, connect it to AC power when not in use.

note

When you charge the battery initially or it is not used for a long period of time, charge it for 12 hours continuously. It takes longer to charge the battery when the parent unit is turned on. To shorten the charging time, turn the parent unit off while charging.

Getting started

Baby unit overview

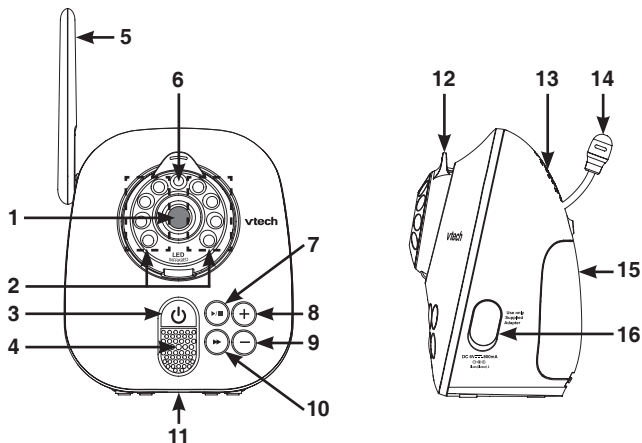

1 – Camera

2 – Infrared LEDs

Backup light for night vision (page 29).

3 –  (On/off)

Press and hold to turn on or off (page 29).

4 – Microphone

5 – Antenna

6 – Light sensor

7 –  (Play/stop)

Press to play lullabies (page 29).

Press to stop playing lullabies (page 29).

8 – + (Volume up)

Press to increase the listening volume (page 29).

9 – – (Volume down)

Press to decrease the listening volume (page 29).

10 –  (Skip)

Press to skip to the next lullaby (page 29).

11 – Threaded socket (1/4 in)

For installation of the provided wall mount (page 4) or a tripod (not provided).

12 – Camera angle adjustment tab

Tilt to adjust camera angle.

13 – Speaker

To listen to lullabies.

To listen to broadcasts from the parent unit.

14 – Temperature sensor

15 – Battery compartment cover

16 – Power jack

Getting started

Baby unit lights

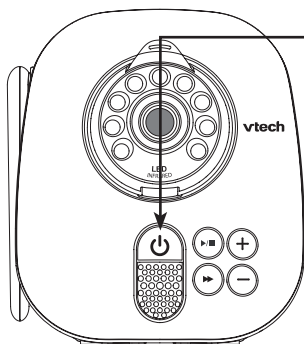

⏻ (On/off)

On in red when the baby unit is powered by batteries.

On in green when the baby unit is powered by AC power.

On in orange when the baby unit is not paired to the parent unit.

Flashes in red when the baby unit battery is low.

Flashes alternately in red and green when the baby unit is in pairing mode.

Getting started

Parent unit overview

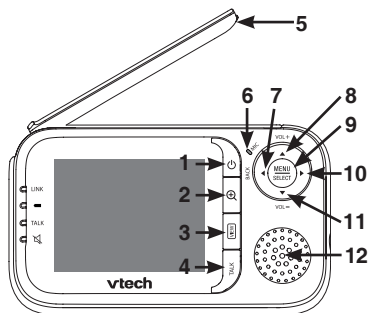

1 – **⏻ (On/off)**

Press and hold to turn on or off (page 30).

2 – **⏏ (Zoom)**

While viewing in single-CAM mode, press to zoom in or out (page 30).

3 – **VIEW (View)**

Press repeatedly to view an individual camera or all cameras at the same time (page 31).

Press and hold to turn off the screen, or press to turn it on (page 31).

4 – **TALK**

While viewing in single-CAM mode, press and hold to talk to the selected baby unit (page 31).

5 – **Antenna**

6 – **MIC (Microphone)**

7 – **⬅/BACK**

While in a menu, press to return to the previous menu (page 21).

While viewing in **⏏** mode, press to move leftward (page 30).

While viewing in multi-CAM mode, press to move left or right to highlight a desired camera (page 30).

8 – **▲/VOL+**

Press to increase the speaker volume (page 30).

While in a menu, press to scroll up.

While viewing in **⏏** mode, press to move upward (page 30).

While viewing in multi-CAM mode, press to scroll up or down to highlight a desired camera (page 30).

9 – **MENU/SELECT**

Press to enter the menu (page 21).

While in a menu, press to choose an item, or save a setting (page 21).

While viewing in multi-CAM mode, press to select a desired camera (page 30).

10 – **▶**

While viewing in **⏏** mode, press to move rightward (page 30).

While in a menu, press to choose an item (page 21).

While viewing in multi-CAM mode, press to move right or left to highlight a desired camera (page 30).

11 – **▼/VOL-**

Press to decrease the speaker volume (page 30).

While in a menu, press to scroll down.

While viewing in **⏏** mode, press to move downward (page 30).

While viewing in multi-CAM mode, press to scroll up or down to highlight a desired camera (page 30).

12 – **Speaker**

To listen to sounds transmitted from the baby units.

Getting started

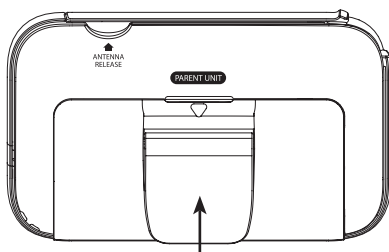

Parent unit overview (continued)



Pull the adjustable stand out to stand on a flat surface.

















Parent unit lights

LINK	On when strong signal strength is detected between the parent unit and the selected baby unit. Flashes when the parent unit cannot link to the selected baby unit. Off when the parent unit is turned off.
	On when the parent unit battery is being charged. Flashes when the parent unit battery is low and needs charging. Off when the parent unit battery is fully charged, or when no battery is installed.
TALK	On when the parent unit is talking to the baby unit.
	On when the parent unit is in multi-CAM mode. On when the speaker volume of the selected baby unit is turned off.

Getting started

Parent unit display screen icons

	Connection status <ul style="list-style-type: none">-  displays when strong signal strength is detected between the baby unit and the parent unit.-  or  displays when moderate signal strength is detected between the baby unit and the parent unit.-  displays when the link between the baby unit and the parent unit is lost.
	Zoom <ul style="list-style-type: none">- Displays when the camera at the selected baby unit has zoomed in.
	Lullaby <ul style="list-style-type: none">- Displays when a lullaby is playing at the selected baby unit.
	Temperature alert <ul style="list-style-type: none">- Displays when the temperature alert is set to on.
57 °F	Real-time temperature <ul style="list-style-type: none">- Displays the real-time temperature of the selected baby unit.
 or 	Sound level indicators <ul style="list-style-type: none">- Displays the sound level according to the scales of loudness when there is sound transmitted from the baby unit. Speaker volume <ul style="list-style-type: none">- Displays the speaker volume level while adjusting.
CAM 1 or CAM 2 or CAM 3 or CAM 4	Current view status <ul style="list-style-type: none">- Displays the number of the baby unit that is being viewed when in single-CAM mode.- Displays the highlighted baby unit when in multi-CAM mode.
	Battery status <ul style="list-style-type: none">-  animates when the battery is charging.-  displays solid when the battery is fully charged.-  displays when the battery is low and needs charging.-  displays when no battery is installed but operates using AC power, or the battery has been installed incorrectly.

Getting started

Positioning and operating range

Position the video and audio monitor

Place the parent unit within the operating range (see below) of the baby unit. We recommend the parent unit is at least 3 feet away from the baby unit to avoid audio feedback. If you still experience audio feedback, move the parent unit and the baby unit farther apart.

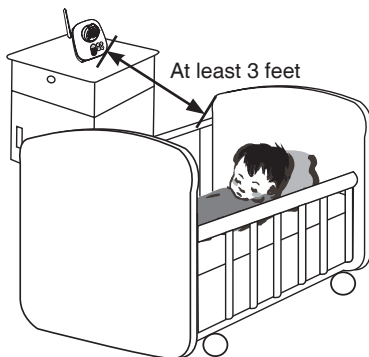

note

For better image quality, do not place the baby unit too far away from your baby.

Audio settings

The baby unit may not detect sounds when the sensitivity level is set below a certain level. You may need to increase the sensitivity level (see page 23).

You may need to turn the speaker volume louder on the parent unit to hear the sounds transmitted from the baby unit (see page 30).

Operating range

The operating range of the video and audio monitor is up to 1,000 feet outdoors or 150 feet indoors. The actual operating range may vary depending on the environmental conditions and other interferences such as walls, doors and other obstructions.

note





It is the caregiver's responsibility to stay close enough to take care of any eventuality.

Getting started

Test your video and audio monitor before use

It is important to test the video and audio monitor when it is installed initially, and at regular times thereafter. Test your parent unit and baby units if they have not been used for a long time or you suspect they are defective.

To test your video and audio monitor:

1. Place the parent unit and the baby units in the same room to test the product. Make sure the baby units are at least 3 feet away from the parent unit.
2. Press and hold  on the baby units until the  (on/off) lights turn on.
3. Press and hold  on the parent unit until the screen displays **Waiting for linking ...**
4. Press  repeatedly on the parent unit to view images from all baby units. If you have only one baby unit, the parent unit displays an image from the baby unit. Your video and audio monitor is now ready for use.

note

If no connection can be established, the parent unit displays **No link to CAM #** for a few seconds. Then it displays **Waiting for linking ...** and .

Parent unit settings

Using the menu

To enter the parent unit menu:

1. Press **MENU/SELECT** when the parent unit is not in use.
2. Press **▼** or **▲** until the desired feature is highlighted on the left side. Press **MENU/SELECT** or **▶** to enter that feature menu.
3. Press **▼** or **▲** until the desired feature or option is highlighted on the right side. Press **MENU/SELECT** or **▶** to enter that feature menu, or press **MENU/SELECT** to confirm your selection. You hear a confirmation tone.

note

To return to the previous menu, press **◀/BACK**.

Alert tone

Low battery tone alert

You can set whether the parent unit beeps whenever the parent unit or the baby unit operates in low battery condition. The low battery tone alert is preset to **On**.



To set the low battery tone alert:

1. Press **MENU/SELECT** when the parent unit is not in use.
2. Press **▼** or **▲** to choose **ALERT TONE**, then press **MENU/SELECT** or **▶**.
3. Press **MENU/SELECT** or **▶** again to choose **Low Battery Tone**.
4. Press **▼** or **▲** to choose **On** or **Off**, then press **MENU/SELECT** to confirm your selection. You hear a confirmation tone.

note

The low battery tone alert of the baby unit only works while viewing that particular baby unit in single-CAM mode or in multi-CAM mode.

Parent unit settings

Alert tone (continued)

No link alert

You can set whether the parent unit beeps whenever the link between the parent unit and the baby unit is lost. The no link alert is preset to **On**.



To set the no link alert of the parent unit:

1. Press **MENU/SELECT** when the parent unit is not in use.
2. Press **▼** or **▲** to choose **ALERT TONE**, then press **MENU/SELECT** or **▶**.
3. Press **▼** or **▲** to choose **No Link Alert**, then press **MENU/SELECT** or **▶**.
4. Press **▼** or **▲** to choose **On** or **Off**, then press **MENU/SELECT** to confirm your selection. You hear a confirmation tone.

note

The no link alert only works while viewing that particular baby unit in single-CAM mode or in multi-CAM mode.

Parent unit settings

Sensitivity

You can use the parent unit to change the sound sensitivity level of the baby units from **Level 1** to **Level 5 (Maximum)**. The higher the sound sensitivity level is set, the more sensitive the baby unit is in detecting sounds for transmitting to the parent unit. The sensitivity level is preset to **Level 3**.



If you want the baby unit to be very sensitive in detecting sounds, you may set the sensitivity level to **Level 5 (Maximum)**, so that the baby unit will always detect any sounds including background noises for transmitting to the parent unit. If you want the baby unit to be less sensitive in detecting sounds, you may set the sensitivity level to a lower level (**Level 1** to **Level 4**), so that the baby unit will transmit sounds to the parent unit only when your baby is very noisy or crying loudly.

To set the sound sensitivity level of the baby unit:

1. Press **MENU/SELECT** when the parent unit is not in use.
2. Press **▼** or **▲** to choose **SENSITIVITY**, then press **MENU/SELECT** or **▶**.
3. Press **▼** or **▲** to choose a desired baby unit or all baby units, then press **MENU/SELECT** or **▶**.
4. Press **▼** or **▲** to scroll through the choices, then press **MENU/SELECT** to confirm your selection. You hear a confirmation tone.

note

To enter the sensitivity menu of the parent unit, the baby units must be turned on.

Parent unit settings

Temperature

Minimum temperature

You can set the desired minimum room temperature of the baby unit. The minimum temperature can be set between **52 °F (11 °C)** and **69 °F (20 °C)**. The minimum temperature is preset to **57 °F (14 °C)**.



To set the minimum temperature of the baby unit:

1. Press **MENU/SELECT** when the parent unit is not in use.
2. Press **▼** or **▲** to choose **TEMPERATURE**, then press **MENU/SELECT** or **▶**.
3. Press **MENU/SELECT** or **▶** again to choose **Minimum**.
4. Press **▼** or **▲** to choose a desired baby unit or all baby units, then press **MENU/SELECT** or **▶**.
5. Press **▼** or **▲** to choose the desired temperature, then press **MENU/SELECT** to confirm your selection. You hear a confirmation tone.

Maximum temperature

You can set the desired maximum room temperature of the baby unit. The maximum temperature can be set between **70 °F (21 °C)** and **86 °F (30 °C)**. The maximum temperature is preset to **85 °F (30 °C)**.

To set the maximum temperature of the baby unit:

1. Press **MENU/SELECT** when the parent unit is not in use.
2. Press **▼** or **▲** to choose **TEMPERATURE**, then press **MENU/SELECT** or **▶**.
3. Press **▼** or **▲** to choose **Maximum**, then press **MENU/SELECT** or **▶**.
4. Press **▼** or **▲** to choose a desired baby unit or all baby units, then press **MENU/SELECT** or **▶**.
5. Press **▼** or **▲** to choose the desired temperature, then press **MENU/SELECT** to confirm your selection. You hear a confirmation tone.

Parent unit settings

Temperature (continued)

Temperature alert

You can set whether the parent unit beeps whenever the temperature is out of the preset temperature range. The temperature alert is preset to **Off**.



To set the temperature alert of the baby unit:

1. Press **MENU/SELECT** when the parent unit is not in use.
2. Press ▼ or ▲ to choose **TEMPERATURE**, then press **MENU/SELECT** or ►.
3. Press ▼ or ▲ to choose **Alert**, then press **MENU/SELECT** or ►.
4. Press ▼ or ▲ to choose a desired baby unit or all baby units, then press **MENU/SELECT** or ►.
5. Press ▼ or ▲ to choose **On** or **Off**, then press **MENU/SELECT** to confirm your selection. You hear a confirmation tone.

note

The temperature alert only works while viewing that particular baby unit in single-CAM mode or in multi-CAM mode.

Temperature format

You can set the temperature scale of the baby unit. The temperature scale is preset to **Fahrenheit**.

To change the temperature scale:

1. Press **MENU/SELECT** when the parent unit is not in use.
2. Press ▼ or ▲ to choose **TEMPERATURE**, then press **MENU/SELECT** or ►.
3. Press ▼ or ▲ to choose **Format**, then press **MENU/SELECT** or ►.
4. Press ▼ or ▲ to choose **Fahrenheit** or **Celsius**, then press **MENU/SELECT** to confirm your selection. You hear a confirmation tone.

Parent unit settings

Vibration

You can set the parent unit to vibrate once whenever there is any sound detected from the baby units after 20 seconds of silence. The vibration setting is preset to **On if speaker is off**.



To change the vibration setting:

1. Press **MENU/SELECT** when the parent unit is not in use.
2. Press **▼** or **▲** to choose **VIBRATION**, then press **MENU/SELECT** or **▶**.
3. Press **▼** or **▲** to choose **On if speaker is off**, **Always on** or **Off**.
 - **On if speaker is off** - The parent unit vibrates once whenever the baby units detect sounds after 20 seconds of silence while the speaker of the parent unit is turned off.
 - **Always on** - The parent unit vibrates once whenever the baby units detect sounds after 20 seconds of silence.
 - **Off** - The parent unit will not vibrate even if the baby units detect sounds.
4. Press **MENU/SELECT** to confirm your selection. You hear a confirmation tone.

note

- If you set the sensitivity level to **Level 5 (Maximum)** (see page 23), the baby unit will be very sensitive and detect any sounds including background noises. These background noises may disrupt the silence and prevent the vibration feature to work properly.
- If you set the vibration setting to **On if speaker off** or **Always on**, the parent unit will vibrate once when you turn the speaker off.

Sound-activated screen

When the parent unit screen is turned off manually (see page 31), you can set the screen to be turned on automatically whenever there are sounds detected from the baby units after 20 seconds of silence. The parent unit screen will turn off automatically when no sounds are detected from the baby units within 50 seconds. The sound-activated screen is preset to **Off**.



To turn the sound-activated screen on or off:

1. Press **MENU/SELECT** when the parent unit is not in use.
2. Press **▼** or **▲** to choose **SOUND-ACTIVATED SCREEN**, then press **MENU/SELECT** or **▶**.
3. Press **▼** or **▲** to choose **On** or **Off**, then press **MENU/SELECT** to confirm your selection. You hear a confirmation tone.

note

- If you set the sensitivity level to **Level 5 (Maximum)** (see page 23), the baby unit will be very sensitive and detect any sounds including background noises. These background noises may disrupt the silence and prevent the sound-activated screen feature to work properly.
- The parent unit will turn on only if the sounds detected are from the last viewed camera.

Parent unit settings

LCD brightness

You can change the brightness of the parent unit screen from **Level 1** to **Level 5**. The LCD brightness is preset to **Level 3**.



To set the brightness of the parent unit screen:

1. Press **MENU/SELECT** when the parent unit is not in use.
2. Press **▼** or **▲** to choose **LCD BRIGHTNESS**, then press **MENU/SELECT** or **▶**.
3. Press **▼** or **▲** to choose the desired brightness.
4. Press **MENU/SELECT** to confirm your selection. You hear a confirmation tone.

Pair/unpair CAM

Pair new CAM

The baby units and parent unit provided are already paired. You can add or replace baby units (**VM301**, purchased separately) to your video and audio monitor system.



You can pair a maximum of four baby units to your parent unit.

Each new baby unit must be paired to the parent unit before use. Make sure you power on the baby unit (see page 29) and the parent unit (see page 30) before pairing.

To pair a baby unit:

1. On the idle parent unit, press **MENU/SELECT**.
2. Press **▼** or **▲** to choose **PAIR/UNPAIR CAM**, then press **MENU/SELECT** or **▶**.
3. Press **MENU/SELECT** or **▶** again to choose **Pair new CAM**.
4. Press **▼** or **▲** to choose a desired baby unit slot, then press **MENU/SELECT**. If you choose an occupied baby unit slot, the new baby unit will replace the existing baby unit.
5. Make sure the new baby unit is turned on. On the new baby unit, immediately press and hold **+** and **-** for 5 seconds when the parent unit screen displays **Please press both [+] and [-] keys on CAM side until POWER indicator flashes Red and Green light**. The **⏻** light on the new baby unit flashes red and green alternately.
6. When pairing is successful, the screen displays the image from the newly paired baby unit. The **⏻** light on the new baby unit turns red when it is powered by AA batteries or turns green when it is powered by AC power.

note

- If pairing fails, the screen displays **Pairing failed**. Try the pairing process again.
- Only one baby unit can be paired at a time.

Parent unit settings

Pair/unpair CAM (continued)

Unpair CAM

Make sure you power on the baby unit and the parent unit before unpairing the baby unit.



To unpair a baby unit:

1. On the idle parent unit, press **MENU/SELECT**.
2. Press ▼ or ▲ to choose **PAIR/UNPAIR CAM**, then press **MENU/SELECT** or ►.
3. Press ▼ or ▲ to choose **Unpair CAM**, then press **MENU/SELECT** or ►.
4. Press ▼ or ▲ to choose a desired baby unit, then press **MENU/SELECT**.
5. Press ⊕ when the screen displays **To unpair CAM # from the system**, press **[zoom] key**.
6. Press **MENU/SELECT** when the screen displays **Press [MENU/SELECT] key to confirm**.
7. When unpairing is successful, the screen displays the image of the next paired baby unit. If there is no paired baby unit, the screen displays **No CAM paired**.

Language

You can select a language (English, French or Spanish) to be used in all screen displays. The screen display language is preset to **English**.







To change the language:

1. Press **MENU/SELECT** when the parent unit is not in use.
2. Press ▼ or ▲ to choose **LANGUAGE (LANGUE if French is set, or IDIOMA if Spanish is set)**, then press **MENU/SELECT** or ►.
3. Press ▼ or ▲ to choose **English, Français** or **Español**, then press **MENU/SELECT** to confirm your selection. You hear a confirmation tone.

Baby unit operation

Power on or off the baby unit

- Press and hold  for 2 seconds to turn on the baby unit. The  light turns on.
- Press and hold  for 2 seconds again to turn off the baby unit. The  light turns off.

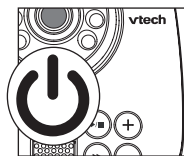

Speaker volume

You can change the speaker volume from **Level 1** to **Level 5**. The preset volume is **Level 3**. Changing the speaker volume also changes the lullaby playback volume.

To adjust the speaker volume:

- Press + or – on the baby unit at any time.

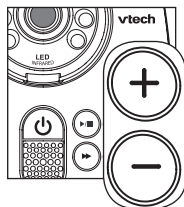

Play lullabies

There are 5 lullabies to choose from, and the chosen lullaby plays repeatedly. The total duration of lullaby playback is about 20 minutes and it starts from where you stopped last time.

To play lullabies:

- Press  on the baby unit.

To skip to the next lullaby:

- Press  on the baby unit to skip to the next lullaby.

To stop playing lullabies:

- Press  on the baby unit to stop.

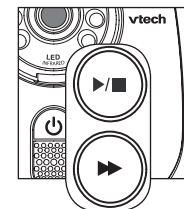

note

Lullaby playback is paused when the parent unit is talking to the baby unit. Lullaby playback resumes when the parent unit finishes using the **TALK** feature.

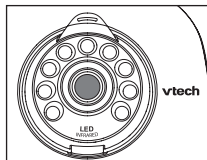

Night vision

To help you monitor your baby even at night, the baby unit automatically uses the light from its infrared LEDs for transmitting images to the parent unit when it is turned on in a dark room. However, it only transmits black-and-white images.



Parent unit operation

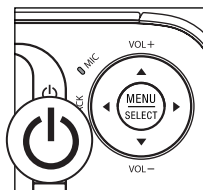

Power on or off the parent unit

- Press and hold  for 2 seconds to turn on the parent unit. The display screen turns on.
- Press and hold  for 2 seconds again to turn off the parent unit. The display screen turns off.





Speaker volume

You can change the speaker volume from **Volume 1** to **Volume 7**, or turn it off. The speaker volume is preset to **Volume 4**.

When the speaker volume is set to off,  appears briefly and the  light turns on.

To adjust the speaker volume:



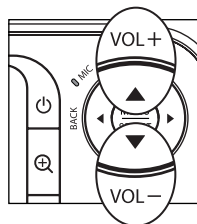



- Press  or  when the parent unit is not in use.













Zoom

You can zoom in or out while viewing images from any baby unit.

To zoom in or out while in single-CAM mode:

- Press  to zoom in. Press , ,  or  to move the zoomed image upward, downward, leftward or rightward correspondingly. Press  again to zoom out.

To zoom in or out while in multi-CAM mode:

- Press , ,  or  to choose the desired baby unit, then press  or **MENU/SELECT**. Press  again to zoom in. Press , ,  or  to move the zoomed image upward, downward, leftward or rightward correspondingly. Press  again to zoom out.

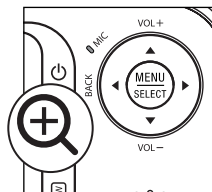

Parent unit operation

View

You can change the screen to view images from different baby units, or you can turn off the screen.

To view different baby units:

Press **VIEW** to scroll to the desired baby units. They are shown in chronological order: **CAM 1**, **CAM 2**, **CAM 3**, **CAM 4** and multi-CAM.

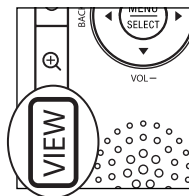

note

When there is only one paired baby unit, multi-CAM mode is not available.

To turn the screen on or off:

- Press and hold **VIEW** for 2 seconds to turn off the screen.
- When the screen is turned off, press any key to turn it on.

Talk to the baby unit

You can broadcast messages from the parent unit to any one of the baby units.

To talk to the baby unit:

1. Press **VIEW** to choose a desired baby unit.
2. Press and hold **TALK** when the parent unit is in single-CAM mode. Speak towards the **MIC** (microphone) on the parent unit. The **TALK** light is on when the voice connection to the baby unit is made. Your voice is broadcast to the baby unit.

note

- The **TALK** feature does not work in multi-CAM mode.
- If the speaker volume of the parent unit is set to **OFF**, it will be reset to the default volume after you press and hold **TALK**.
- Lullaby playback is paused when the parent unit is talking the baby unit. Lullaby playback resumes when the parent unit finishes using the **TALK** feature.

Appendix

Parent unit display screen messages

Battery low at CAM #	When the baby unit is powered by batteries, the stated baby unit batteries need to be changed. It will be powered off after 30 seconds automatically.
Battery low at Parent Unit	When the parent unit is powered by the rechargeable battery and the battery level is low, it needs to be recharged.
Battery empty at Parent Unit	When the parent unit is powered by the rechargeable battery and it is almost depleted, it needs to be recharged. The parent unit will be powered off after 10 seconds.
Battery empty Powering off ...	The parent unit battery is depleted and the parent unit is turning off.
No link to CAM #	The selected camera slot is not linked to the parent unit.
Only one camera paired. View switching requires additional cameras.	You try to view in multi-CAM mode but you have only one paired baby unit.
Sound detected at CAM #	There are sounds detected from the selected baby unit while viewing in multi-CAM mode.
Temperature too low at CAM #	The temperature detected from the selected baby unit is below the set minimum temperature.
Temperature too high at CAM #	The temperature detected from the selected baby unit is above the set maximum temperature.
Waiting for linking...	<p>The link between the parent unit and the selected baby unit is lost, or the selected baby unit is out of range, or the selected camera slot is empty.</p> <p>When you have only one paired baby unit and the link is lost, or you have multiple paired baby units and the links are lost, Waiting for linking... displays for 10 seconds and then the screen turns off.</p>



Appendix

Parent unit battery

It takes up to 12 hours for the battery to be fully charged.

The standby time varies depending on the sensitivity level you set, your actual use and the age of the battery.

The battery needs charging when:

- A new battery is installed in the parent unit.
- The parent unit beeps.
- The battery is properly installed and no battery icon displays on the screen.
- **Battery low at Parent Unit** and  displays on the parent unit.
- The  light flashes on the parent unit.

CAUTION:

To reduce the risk of fire or injury, read and follow these instructions:

- Use only the battery provided or equivalent. To order a replacement, visit our website at www.babymonitors.vtech.com or call 1 (800) 595-9511. In Canada, go to www.vtechcanada.com or call 1 (800) 267-7377.
- Do not dispose of the battery in a fire. Check with local waste management codes for special disposal instructions.
- Do not open or mutilate the battery. Released electrolyte is corrosive and may cause burns or injury to the eyes or skin. The electrolyte may be toxic if swallowed.
- Exercise care in handling the battery in order not to create a short circuit with conductive materials.
- Charge the battery provided with or identified for use with this product only in accordance with the instructions and limitations specified in this manual.
- Observe proper polarity orientation between the battery and metallic contacts.
- To prevent fire or shock hazard, do not expose this product to water or any type of moisture.

Appendix

Troubleshooting

If you have difficulty with your video and audio monitor, please try the suggestions below. For customer service, visit our website at www.babymonitors.vtech.com or call 1 (800) 595-9511. In Canada, go to www.vtechcanada.com or call 1 (800) 267-7377.

My video and audio monitor does not work at all.

- Make sure the baby units, parent unit and the batteries are installed and charged correctly (pages 2 to 12). For optimum daily performance, charge the parent unit when it is not in use.
- Make sure the power adapters are securely plugged into the outlet not controlled by a wall switch.
- Make sure the adapter cords are plugged firmly into the baby units and parent unit.
- Make sure the baby units and the parent unit are turned on.
- The parent unit may be too far away from the baby units. Move the parent unit closer to the baby units (but not less than 3 feet).
- Unplug the electrical power to the baby units and parent unit. Wait for approximately 15 seconds, then plug it back in. Turn on the baby units and the parent unit. Allow up to one minute for the baby units and the parent unit to synchronize.
- Install the correct type of batteries in the baby units and follow the proper polarity orientation **between the battery and metallic contacts inside the battery compartment**.
- Charge the battery in the parent unit for up to 12 hours.
- If the parent unit battery is completely depleted, it may take up to 30 minutes to charge the parent unit before it can be used for a short time (page 13).
- Remove the battery and then install it again. If that still does not work, it may be necessary to purchase new batteries.
- Large obstructions may impact the reception. Try to relocate the baby units, away from large obstructions such as walls and doors.
- Other electronic products may cause interference with your video and audio monitor. Try installing your video and audio monitor as far away from these electronic devices as possible: wireless routers, radios, cellular telephones, intercoms, room monitors, televisions, personal computers, kitchen appliances and cordless telephones.

The video and audio monitor produces high-pitched noise.

- The parent unit may be too close to the baby units. Make sure the parent unit and the baby units are at least 3 feet away from one another.
- You may be too close to the baby unit when you press and hold **TALK**. Make sure the parent unit and the baby units are at least 3 feet away from one another.
- You may have set the sensitivity level too high. You may need to adjust the sensitivity level to a lower level to avoid audio feedback (page 23).

Appendix

Troubleshooting (continued)

The parent unit plays any sounds from the baby unit and I think it is too noisy.

- You may have set the sensitivity level to **Level 5 (Maximum)**. If you do so, the baby unit will transmit any sounds detected to the parent unit. You may need to adjust the sensitivity level to a lower level (page 23).
- You may need to adjust the speaker volume on the parent unit (page 30).

The parent unit does not play any sound when there is noise from the baby unit.

- Make sure the parent unit is powered up by connecting it to AC power (page 12) or to the rechargeable battery provided (page 10).
- Make sure the parent unit is turned on (page 30) and the speaker volume is not set to off (page 30).
- Make sure the parent unit is not monitoring in multi-CAM mode.
- The parent unit may be too far away from the baby unit. Move the parent unit closer to the baby unit (but not less than 3 feet).
- If the parent unit is powered by the provided battery, make sure there is sufficient charge. Charge the battery in the parent unit for up to 12 hours.
- You may have set the sensitivity level to a very low level. If you do so, the baby unit will not detect sounds that is too soft or light. You may need to adjust the sensitivity level to a higher level (page 23).
- Large obstructions may impact the reception. Try to relocate the baby unit, away from large obstructions such as walls and doors.
- Remove the battery and then install it again. Turn on the baby unit and the parent unit. Allow up to one minute for the parent unit and the baby unit to synchronize.
- Other electronic products may cause interference with your video and audio monitor. Try installing your video and audio monitor as far away from these electronic devices as possible: wireless routers, radios, cellular telephones, intercoms, room monitors, televisions, personal computers, kitchen appliances and cordless telephones.



Battery low at the Parent Unit and display on the parent unit.

- Charge the battery in the parent unit for up to 12 hours.
- Remove the battery and then install it again. Use it until fully depleted, then recharge it in the parent unit for up to 12 hours.
- If the above measures do not correct the problem, replace the battery.

Appendix

Troubleshooting (continued)

The battery does not charge in the parent unit or the parent unit battery does not accept charge.

- Make sure the battery is installed in the parent unit battery compartment correctly. The  light on the parent unit should be on when charging.
- Remove the battery and then install it again, then charge for up to 12 hours.
- If the battery icon and the  light on the parent unit are not on, refer to **The  light on the parent unit is off** below.
- If the battery is completely depleted, it may take up to 30 minutes to charge the parent unit before it can be used for a short time (page 13).
- Purchase a new battery. Refer to **Parent unit battery installation** (pages 10-11) and **Parent unit battery charging** (page 13).

The light on the parent unit is off.

- Make sure the parent unit battery is installed (page 10) and charged (page 13) correctly.
- The  light is off when the battery is fully charged even if it is also powered by AC power.

The parent unit beeps and is not performing normally.

- Move the parent unit closer to the baby units (but not less than 3 feet). The baby units may be out of range.
- If the parent unit is powered by the provided battery, it may not have enough charge for the parent unit to perform normally. Charge the battery in the parent unit for up to 12 hours.
- Reset the parent unit and the baby units by turning them off and unplugging the electrical power to the parent unit and the baby units. Wait for 15 seconds and plug them back in again. Turn on the parent unit and the baby units. Allow up to one minute for the parent unit and the baby units to synchronize.
- Other electronic products may cause interference with your video and audio monitor. Try installing your video and audio monitor as far away from these electronic devices as possible: wireless routers, radios, cellular telephones, intercoms, room monitors, televisions, personal computers, kitchen appliances and cordless telephones.

Appendix

Troubleshooting (continued)

The link between the baby unit and the parent unit is lost every now and then, and I'm experiencing sound interruptions.

- Move the parent unit closer to the baby unit (but not less than 3 feet). The baby units may be out of range.
- Reset the parent unit and the baby unit by turning them off and unplugging the electrical power to the parent unit and the baby unit. Wait for 15 seconds and plug them back in again. Turn on the baby unit and the parent unit. Allow up to one minute for the parent unit and the baby unit to synchronize.
- Other electronic products may cause interference with your video and audio monitor. Try installing your video and audio monitor as far away from these electronic devices as possible: wireless routers, radios, cellular telephones, intercoms, room monitors, televisions, personal computers, kitchen appliances and cordless telephones.

The parent unit displays Waiting for linking...

- Move the parent unit closer to the baby unit (but not less than 3 feet). The baby units may be out of range.
- Reset the parent unit and the baby unit by turning them off and unplugging the electrical power to the parent unit and the baby unit. Wait for 15 seconds and plug them back in again. Turn on the baby unit and the parent unit. Allow up to one minute for the parent unit and the baby unit to synchronize.
- Other electronic products may cause interference with your video and audio monitor. Try installing your video and audio monitor as far away from these electronic devices as possible: wireless routers, radios, cellular telephones, intercoms, room monitors, televisions, personal computers, kitchen appliances and cordless telephones.

Common cure for electronic equipment.

- If the video and audio monitor is not responding normally, try the following (in the order listed):
 1. Disconnect the power to the baby units and the parent unit.
 2. Remove the batteries in the baby units and the parent unit. Then install the batteries again.
 3. Wait a few minutes before connecting power back to the baby units and the parent unit.
 4. Turn on the baby units and the parent unit.
 5. Wait for the parent unit to synchronize with the baby units. Allow up to one minute for this to take place.

Appendix

Operating range

This product operates with the maximum power allowed by the Federal Communications Commission (FCC). Even so, this baby unit and parent unit can communicate over only a certain distance - which can vary with the locations of the baby unit, the parent unit, the weather, and the layout of your home.

When the baby unit is out of range, the parent unit displays **Waiting for linking...**

To improve reception, move closer to the baby unit (but not less than 3 feet).

Energy-saving charging mode

When this mode is activated, all functions, except parent unit battery charging, will be disabled.

To activate the energy-saving charging mode on a parent unit:

1. Unplug the parent unit and baby unit power adapters from the power outlets. Make sure the parent unit is plugged with charged battery before proceeding.
2. Follow the instructions on page 28 to unpair all baby units.
3. Remove the battery from the parent unit and then install it back in again. Then plug the parent unit power adapter back to the power outlet.



When the parent unit successfully enters the energy-saving charging mode, the screen displays **No CAM paired**.

When the parent unit fails to enter this mode, repeat Step 1 through Step 3 above.

To deactivate the energy-saving charging mode:

- Follow the instructions on page 27 to pair the baby units back to the parent unit.

Precautions for users of implanted cardiac pacemakers

Cardiac pacemakers (applies only to digital cordless devices):

Wireless Technology Research, LLC (WTR), an independent research entity, led a multidisciplinary evaluation of the interference between portable wireless devices and implanted cardiac pacemakers. Supported by the U.S. Food and Drug Administration, WTR recommends to physicians that:

Pacemaker patients

- Should keep wireless devices at least six inches from the pacemaker.
- Should NOT place wireless devices directly over the pacemaker, such as in a breast pocket, when it is turned ON.

WTR's evaluation did not identify any risk to bystanders with pacemakers from other persons using wireless devices.

Appendix

Maintenance

Taking care of your video and audio monitor

Your video and audio monitor contains sophisticated electronic parts, so it must be treated with care.

Avoid rough treatment

Place the baby unit and parent unit down gently. Save the original packing materials to protect your video and audio monitor if you ever need to ship it.

Avoid water

Your video and audio monitor can be damaged if it gets wet. Do not use the parent unit and/or baby unit outdoors in the rain, or handle it with wet hands. Do not install the video and audio monitor near a sink, bathtub or shower.

Electrical storms

Electrical storms can sometimes cause power surges harmful to electronic equipment. For your own safety, take caution when using electrical appliances during storms.

Cleaning your video and audio monitor

Your video and audio monitor has a durable plastic casing that should retain its luster for many years. Clean it only with a soft cloth slightly dampened with water or mild soap. Do not use excess water or cleaning solvents of any kind.

Remember that electrical appliances can cause serious injury if used when you are wet or standing in water. If the baby units and/or parent unit should fall into water, **DO NOT RETRIEVE IT UNTIL YOU UNPLUG THE POWER CORDS FROM THE WALL.** Then pull the units out by the unplugged cords.

The RBRC® seal

The RBRC® seal on the lithium-ion battery indicates that VTech Communications, Inc. is voluntarily participating in an industry program to collect and recycle these batteries at the end of their useful lives, when taken out of service within the United States and Canada.

The RBRC® program provides a convenient alternative to placing used lithium-ion batteries into the trash or municipal waste, which may be illegal in your area.

VTech's participation in RBRC® makes it easy for you to drop off the spent battery at local retailers participating in the RBRC® program or at authorized VTech product service centers. Please call **1 (800) 8 BATTERY™** for information on Li-ion battery recycling and disposal bans/restrictions in your area. VTech's involvement in this program is part of its commitment to protecting our environment and conserving natural resources.

RBRC® is a registered trademark of Rechargeable Battery Recycling Corporation.



Appendix

Limited warranty

What does this limited warranty cover?

The manufacturer of this VTech Product warrants to the holder of a valid proof of purchase (“Consumer” or “you”) that the Product and all accessories provided in the sales package (“Product”) are free from defects in material and workmanship, pursuant to the following terms and conditions, when installed and used normally and in accordance with the Product operating instructions. This limited warranty extends only to the Consumer for Products purchased and used in the United States of America and Canada.

What will VTech do if the Product is not free from defects in materials and workmanship during the limited warranty period (“Materially Defective Product”)?

During the limited warranty period, VTech’s authorized service representative will repair or replace at VTech’s option, without charge, a Materially Defective Product. If we repair the Product, we may use new or refurbished replacement parts. If we choose to replace the Product, we may replace it with a new or refurbished Product of the same or similar design. We will retain defective parts, modules, or equipment. Repair or replacement of the Product, at VTech’s option, is your exclusive remedy. VTech will return the repaired or replacement Products to you in working condition. You should expect the repair or replacement to take approximately 30 days.

How long is the limited warranty period?

The limited warranty period for the Product extends for ONE (1) YEAR from the date of purchase. If VTech repairs or replaces a Materially Defective Product under the terms of this limited warranty, this limited warranty also applies to the repaired or replacement Product for a period of either (a) 90 days from the date the repaired or replacement Product is shipped to you or (b) the time remaining on the original one-year warranty; whichever is longer.

What is not covered by this limited warranty?

This limited warranty does not cover:

1. Product that has been subjected to misuse, accident, shipping or other physical damage, improper installation, abnormal operation or handling, neglect, inundation, fire, water or other liquid intrusion; or
2. Product that has been damaged due to repair, alteration or modification by anyone other than an authorized service representative of VTech; or
3. Product to the extent that the problem experienced is caused by signal conditions, network reliability, or cable or antenna systems; or
4. Product to the extent that the problem is caused by use with non-VTech accessories; or
5. Product whose warranty/quality stickers, product serial number plates or electronic serial numbers have been removed, altered or rendered illegible; or
6. Product purchased, used, serviced, or shipped for repair from outside the United States of America or Canada, or used for commercial or institutional purposes (including but not limited to Products used for rental purposes); or
7. Product returned without a valid proof of purchase (see item 2 on the next page); or
8. Charges for installation or set up, adjustment of customer controls, and installation or repair of systems outside the unit.

Appendix

Limited warranty (continued)

How do you get warranty service?

To obtain warranty service in the United States of America, visit www.babymonitors.vtech.com or call 1 (800) 595-9511. In Canada, go to www.vtechcanada.com or call 1 (800) 267-7377. NOTE: Before calling for service, please review the user's manual - a check of the Product's controls and features may save you a service call.

Except as provided by applicable law, you assume the risk of loss or damage during transit and transportation and are responsible for delivery or handling charges incurred in the transport of the Product(s) to the service location. VTech will return repaired or replaced Product under this limited warranty. Transportation, delivery or handling charges are prepaid. VTech assumes no risk for damage or loss of the Product in transit. If the Product failure is not covered by this limited warranty, or proof of purchase does not meet the terms of this limited warranty, VTech will notify you and will request that you authorize the cost of repair prior to any further repair activity. You must pay for the cost of repair and return shipping costs for the repair of Products that are not covered by this limited warranty.

What must you return with the Product to get warranty service?

1. Return the entire original package and contents including the Product to the VTech service location along with a description of the malfunction or difficulty; and
2. Include a "valid proof of purchase" (sales receipt) identifying the Product purchased (Product model) and the date of purchase or receipt; and
3. Provide your name, complete and correct mailing address, and telephone number.

Other limitations

This warranty is the complete and exclusive agreement between you and VTech. It supersedes all other written or oral communications related to this Product. VTech provides no other warranties for this Product. The warranty exclusively describes all of VTech's responsibilities regarding the Product. There are no other express warranties. No one is authorized to make modifications to this limited warranty and you should not rely on any such modification.

State/Provincial Law Rights: This warranty gives you specific legal rights, and you may also have other rights, which vary from state to state or province to province.

Limitations: Implied warranties, including those of fitness for a particular purpose and merchantability (an unwritten warranty that the Product is fit for ordinary use) are limited to one year from the date of purchase. Some states/provinces do not allow limitations on how long an implied warranty lasts, so the above limitation may not apply to you. In no event shall VTech be liable for any indirect, special, incidental, consequential, or similar damages (including, but not limited to lost profits or revenue, inability to use the Product or other associated equipment, the cost of substitute equipment, and claims by third parties) resulting from the use of this Product. Some states/provinces do not allow the exclusion or limitation of incidental or consequential damages, so the above limitation or exclusion may not apply to you.

Please retain your original sales receipt as proof of purchase.

Appendix

FCC and IC regulations

FCC Part 15

This equipment has been tested and found to comply with the requirements for a Class B digital device under Part 15 of the Federal Communications Commission (FCC) rules. These requirements are intended to provide reasonable protection against harmful interference in a residential installation. This equipment generates, uses and can radiate radio frequency energy and, if not installed and used in accordance with the instructions, may cause harmful interference to radio communications. However, there is no guarantee that interference will not occur in a particular installation. If this equipment does cause harmful interference to radio or television reception, which can be determined by turning the equipment off and on, the user is encouraged to try to correct the interference by one or more of the following measures:

- Reorient or relocate the receiving antenna.
- Increase the separation between the equipment and receiver.
- Connect the equipment into an outlet on a circuit different from that to which the receiver is connected.
- Consult the dealer or an experienced radio/TV technician for help.

Changes or modifications to this equipment not expressly approved by the party responsible for compliance could void the user's authority to operate the equipment.

This device complies with Part 15 of the FCC rules. Operation is subject to the following two conditions: (1) this device may not cause harmful interference, and (2) this device must accept any interference received, including interference that may cause undesired operation.

To ensure safety of users, the FCC has established criteria for the amount of radio frequency energy that can be safely absorbed by a user or bystander according to the intended usage of the product. This product has been tested and found to comply with the FCC criteria. The baby unit shall be installed and used such that parts of the baby's body are maintained at a distance of approximately 8 in (20 cm) or more.

This Class B digital apparatus complies with Canadian ICES-003.

Industry Canada

Operation is subject to the following two conditions: (1) this device may not cause harmful interference, and (2) this device must accept any interference, including interference that may cause undesired operation.

The term "IC:" before the certification/registration number only signifies that the Industry Canada technical specifications were met.

This product meets the applicable Industry Canada technical specifications.

RF radiation exposure statement

The baby unit complies with FCC RF radiation exposure limits set forth for an uncontrolled environment. The baby unit should be installed and operated with a minimum distance of 8 in (20 cm) between the baby unit and the baby's body. Use of other accessories may not ensure compliance with FCC RF exposure guidelines. This transmitter must not be co-located or operating in conjunction with any other antenna or transmitter. This equipment complies also with Industry Canada RSS-102 with respect to Canada's Health Code 6 for Exposure of Humans to RF Fields.

Appendix

Technical specifications

Frequency control	Crystal controlled PLL synthesizer
Transmit frequency	Baby unit: 2402 - 2478.5 MHz Parent unit: 2402 -2478.5 MHz
Channels	52
LCD	2.8" Color LCD (QVGA 320x240 pixel)
Nominal effective range	Maximum power allowed by FCC and IC. Actual operating range may vary according to environmental conditions at the time of use.
Power requirements	Baby unit: 4 x AA alkaline batteries Parent unit: 3.7V Li-polymer battery Baby unit power adapter: Input: 100-120V AC 50/60Hz Output: 6V DC @ 800mA Parent unit power adapter: Input: 100-120V AC 50/60Hz Output: 6V DC @ 800mA

Index

A

- Add a baby unit 27
- Alert 21, 22, 25
- Alert tone 21
- Audio settings 19

B

- Baby unit battery installation 2
- Baby unit installation 3
- Baby unit installation options 4
- Baby unit lights 15
- Baby unit operation 29
- Baby unit overview 14
- Battery 33
- Battery charging 13
- Battery installation 2, 10–11
- Brightness 27

C

- Cardiac pacemakers 39
- Charging 13

D

- Deregister a baby unit 28
- Display screen icons 18
- Display screen messages 32

F

- FCC and IC regulations 42

I

- Icons 18
- Important safety instructions iii–iv
- Installation 2, 3, 4, 10–11, 12

L

- Language 28
- LCD brightness 27
- LCD language 28
- Lights 15, 17
- Limited warranty 40–41
- Low battery tone alert 21
- Lullabies 29

M

- Maintenance 38
- Maximum temperature 24
- Menu 21
- Minimum temperature 24
- Multi-CAM mode 30

N

- Night vision 29
- Noise sensitivity 23
- No link alert 22

O

- Operating range 19, 38
- Operation 29–31
- Overview 14, 16–17

P

- Pacemaker patients 39
- Pair a baby unit 27
- Pair CAM 27
- Parent unit battery 33
- Parent unit battery charging 13
- Parent unit battery installation 10–11
- Parent unit display screen icons 18
- Parent unit display screen messages 32
- Parent unit installation 12
- Parent unit lights 17
- Parent unit overview 16–17
- Parent unit settings 21–28
- Parts checklist 1
- Play lullabies 29
- Positioning 19
- Power off the baby unit 29
- Power off the parent unit 30
- Power on the baby unit 29
- Power on the parent unit 30

R

- Range 19, 38
- Register a baby unit 27
- Remove a baby unit 28

Index

S

- Safety instructions iii–iv
- Screen icons 18
- Screen messages 32
- Self-adhesive strap 3, 12
- Sensitivity 23
- Settings 21–28
- Single-CAM mode 30
- Sound-activated screen 26
- Sound sensitivity 23
- Speaker volume 29, 30

T

- Talk to the baby unit 31
- Technical specifications 43
- Temperature 24–25
- Temperature alert 25
- Temperature format 25
- Temperature scale 25
- Test your video and audio monitor 20
- Troubleshooting 34–37
- Turn off the baby unit 29
- Turn off the parent unit 30
- Turn on the baby unit 29
- Turn on the parent unit 30
- Turn the parent unit screen on or off 31

U

- Unpair a baby unit 28
- Unpair CAM 28
- Using the menu 21

V

- Vibration 26
- View 31
- Volume 29, 30

W

- Wall mount installation 4–9
- Warranty 40–41

Z

- Zoom 30

VTECH TELECOMMUNICATIONS LTD.

A member of THE VTECH GROUP OF COMPANIES.

Distributed in the U.S.A. by VTech Communications, Inc., Beaverton, Oregon 97008.

Distributed in Canada by VTech Technologies Canada Ltd., Richmond, B.C. V6W 1L5.

VTech is the registered trademark of VTech Holdings Limited.

Copyright © 2013 for VTECH TELECOMMUNICATIONS LTD.

All rights reserved. Printed in China.

91-006751-010-100

vtech®